

431299

CATALOGED BY DDC  
AS AD NO

431299

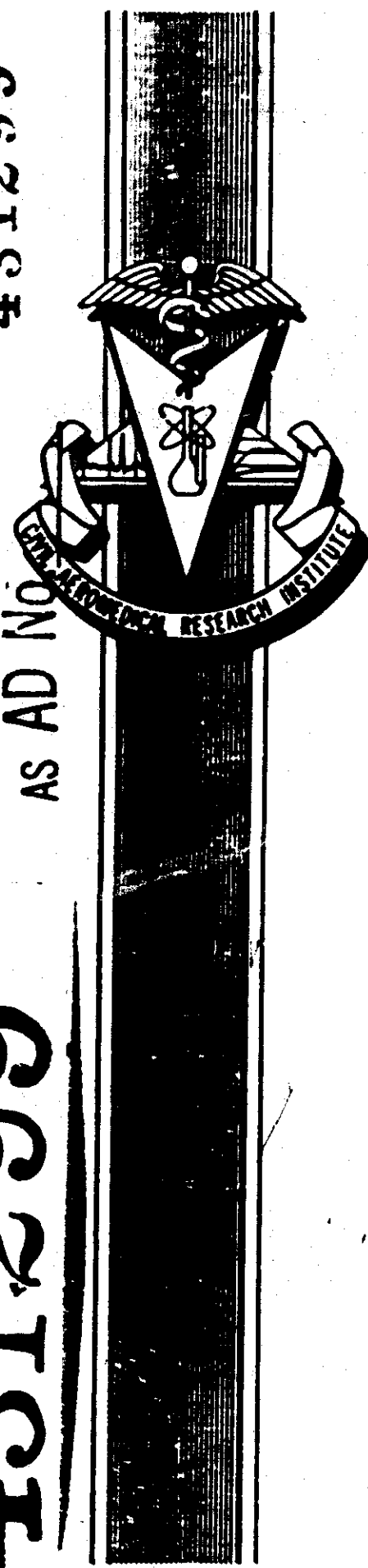

MECHANISMS OF ACTION OF  
THE INSECTICIDE ENDRIN

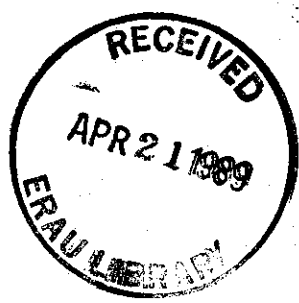

63-16

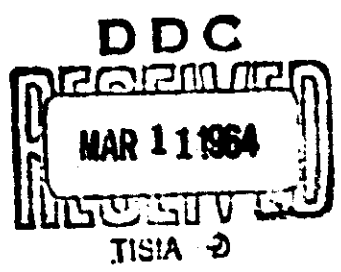

FEDERAL AVIATION AGENCY  
AVIATION MEDICAL SERVICE  
AEROMEDICAL RESEARCH DIVISION  
CIVIL AEROMEDICAL RESEARCH INSTITUTE  
OKLAHOMA CITY, OKLAHOMA

AUGUST 1963

Civil Aeronautical Research Institute, Federal Aviation Agency, Oklahoma City, Oklahoma. CARI Report 63-16. MECHANISMS OF ACTION OF THE INSECTICIDE ENDRIIN by Thomas E. Emerson, Jr., Charles M. Brake and Lerner B. Hinshaw.

1. Insecticides
2. Toxicology
3. Hemodynamics
4. Hematology

Cardiovascular effects of endrin insecticide are obscure. Experiments to investigate these phenomena were carried out on dogs and suggested mechanisms of action have been proposed. Results show that acute administration of endrin produces bradycardia, hypertension, copious salivation, hyperexcitability, tonic-clonic convulsions, increased body temperature, leukocytosis, hemocoagulation and decreased blood pH. Cerebral venous pressure and cerebrospinal fluid pressure elevations are also prominent features of endrin poisoning. Although most of these effects appear to be caused by endrin acting directly on the central nervous system some may result secondarily from altered cerebral hemodynamics.

Civil Aeronautical Research Institute, Federal Aviation Agency, Oklahoma City, Oklahoma. CARI Report 63-16. MECHANISMS OF ACTION OF THE INSECTICIDE ENDRIIN by Thomas E. Emerson, Jr., Charles M. Brake and Lerner B. Hinshaw.

1. Insecticides
2. Toxicology
3. Hemodynamics
4. Hematology

Cardiovascular effects of endrin insecticide are obscure. Experiments to investigate these phenomena were carried out on dogs and suggested mechanisms of action have been proposed. Results show that acute administration of endrin produces bradycardia, hypertension, copious salivation, hyperexcitability, tonic-clonic convulsions, increased body temperature, leukocytosis, hemocoagulation and decreased blood pH. Cerebral venous pressure and cerebrospinal fluid pressure elevations are also prominent features of endrin poisoning. Although most of these effects appear to be caused by endrin acting directly on the central nervous system some may result secondarily from altered cerebral hemodynamics.

Civil Aeronautical Research Institute, Federal Aviation Agency, Oklahoma City, Oklahoma. CARI Report 63-16. MECHANISMS OF ACTION OF THE INSECTICIDE ENDRIIN by Thomas E. Emerson, Jr., Charles M. Brake and Lerner B. Hinshaw.

1. Insecticides
2. Toxicology
3. Hemodynamics
4. Hematology

Cardiovascular effects of endrin insecticide are obscure. Experiments to investigate these phenomena were carried out on dogs and suggested mechanisms of action have been proposed. Results show that acute administration of endrin produces bradycardia, hypertension, copious salivation, hyperexcitability, tonic-clonic convulsions, increased body temperature, leukocytosis, hemocoagulation and decreased blood pH. Cerebral venous pressure and cerebrospinal fluid pressure elevations are also prominent features of endrin poisoning. Although most of these effects appear to be caused by endrin acting directly on the central nervous system some may result secondarily from altered cerebral hemodynamics.

Civil Aeronautical Research Institute, Federal Aviation Agency, Oklahoma City, Oklahoma. CARI Report 63-16. MECHANISMS OF ACTION OF THE INSECTICIDE ENDRIIN by Thomas E. Emerson, Jr., Charles M. Brake and Lerner B. Hinshaw.

1. Insecticides
2. Toxicology
3. Hemodynamics
4. Hematology

Cardiovascular effects of endrin insecticide are obscure. Experiments to investigate these phenomena were carried out on dogs and suggested mechanisms of action have been proposed. Results show that acute administration of endrin produces bradycardia, hypertension, copious salivation, hyperexcitability, tonic-clonic convulsions, increased body temperature, leukocytosis, hemocoagulation and decreased blood pH. Cerebral venous pressure and cerebrospinal fluid pressure elevations are also prominent features of endrin poisoning. Although most of these effects appear to be caused by endrin acting directly on the central nervous system some may result secondarily from altered cerebral hemodynamics.

**MECHANISMS OF ACTION OF  
THE INSECTICIDE ENDRIN**

**THOMAS E. EMERSON, JR.**

**CHARLES M. BRAKE**

**LERNER B. HINSHAW**

*Environmental Physiology Branch  
Civil Aeromedical Research Institute*

**63-16**

**FEDERAL AVIATION AGENCY  
AVIATION MEDICAL SERVICE  
AEROMEDICAL RESEARCH DIVISION  
CIVIL AEROMEDICAL RESEARCH INSTITUTE  
OKLAHOMA CITY, OKLAHOMA**

**AUGUST 1963**

## MECHANISMS OF ACTION OF THE INSECTICIDE ENDRIN

Thomas E. Emerson, Jr., Charles M. Brake, and Lerner B. Hershaw

Acute lethal and sub-lethal poisoning by chlorinated hydrocarbon insecticides has been reported in man (1-12) and animals (11-17). Signs and symptoms following absorption of large amounts of chlorinated hydrocarbon insecticide, include hyperexcitability, tremors, ataxia, tonic-clonic convulsions, dyspnea, coma and not infrequently death (1, 5, 13). Fever (1, 5, 6, 8) and gastrointestinal disturbances (1, 12) have also been noted clinically. Headache, blurred vision, ataxia, tremors and mental confusion often accompany absorption of smaller amounts of these insecticides. Hematological alterations are not well defined. Clinical test on patients, ordinarily carried out several days after exposure, indicate variable effects on erythrocyte (1, 6, 8) and leukocyte (1, 2, 5-8) concentration.

Chlorinated hydrocarbon insecticides include endrin, dieldrin, aldrin, chlordane, lindane, and DDT, among others. They accumulate in body fat (12, 18-20) and fatty tissue of the liver, kidney and brain (21). Endrin,\* the most potent member of this group (22), has received little attention and was chosen for the present study. It is insoluble in water, but soluble to varying degrees in oil; absorption is by ingestion, inhalation or through the unbroken skin (13). Little is known concerning the cardiovascular changes following acute exposure to lethal amounts of endrin insecti-

cide. The following experiments were therefore undertaken to determine the cardiovascular effects of endrin.

### METHODS

In thirty experiments male and female mongrel dogs weighing from 10 to 19 kg were intravenously anesthetized with sodium pentobarbital (30 mg/kg body weight), and studied as described below.

#### Group I — General systemic effects of endrin

A. *Initial experiments.* Lethal amounts of endrin, 10 mg/kg body weight in 95% ethanol (25 mg/ml), were infused intravenously at 0.5 ml/minute in four experiments. Alcohol blank infusions at the rate and volume used with endrin were also administered.

A femoral vein was cannulated with polyethylene tubing for drug administration and for obtaining blood samples. Systemic arterial blood pressure and heart rate were continuously monitored through a cannulated femoral artery with a Statham pressure transducer and recorded on a Sanborn direct-writing recorder. Rectal temperature was measured using either a rectal probe and telethermometer or a mercury thermometer. Blood PH was measured with a Beckman Expanded scale pH meter. Hematocrits were determined in 1 cc Wintrobe tubes centrifuged at 3,000 rpm for 30 minutes. Leukocyte and differential counts with Wright's stain were carried out using standard techniques.

\* (1, 2, 3, 4, 10, 10-Hexachloro-6, 7-epoxy-1, 4, 4a, 5, 6, 7, 8, 8a-octahydro-1, 4-endo, endo-5, 8-dimethanonaphthalene; Hexachlorooctahydroendo, endo-dimethanonaphthalene.)

It was necessary to give large amounts of sodium pentobarbital after endrin administration.

**B. Experiments with succinylcholine.** The following experiments were carried out to avoid the depressant effects of additional barbiturate. Five dogs were given 3-10 mg of succinylcholine chloride (Anectine\*) intravenously to prevent convulsions. Three animals received this drug several minutes before endrin, while it was given after endrin to two. Artificial respiration was necessary and the rate was usually adjusted in an effort to maintain blood pH within the physiological range. Except for a tracheotomy and artificial respiration, these animals were treated identically to those in group 1-A.

**C. Control experiments.** Six animals were treated as in 1-B, except that endrin was not given.

#### **Group 2 — Effect of endrin on heart rate**

Heart rate and systemic arterial blood pressure were measured in five dogs as in the preceding group. Succinylcholine was given as described above. After lethal infusions of endrin, heart rates were followed until the cardiac effect was pronounced. Atropine (0.5 mg) was then injected intravenously.

#### **Group 3 — Effect of endrin on cerebrospinal fluid pressure**

Cerebrospinal fluid (CSF) pressure was measured from a spinal needle placed in the cisterna magna in five animals. A Statham pressure transducer and Sanborn recorder were used to record this pressure. Systemic arterial blood pressure and heart rate were monitored as described above. In three additional dogs sagittal venous sinus pressure, obtained with an 18 gauge needle placed in the sagittal sinus through a burr hole in the skull, and internal jugular vein pressure also were measured with Statham pressure transducers. A needle was inserted into the subarachnoid space and the pressure at this site was measured in one experiment. This pressure was compared with the simultaneously obtained CSF pressure. In one experiment CSF pressure was maintained near control pressure following endrin by with-

\*obtained from Burroughs Wellcome & Co.

drawing spinal fluid. The Queckenstedt was usually carried out before and after endrin administration. Alcohol blank infusions were also tested. All animals received succinylcholine to prevent convulsions.

## **RESULTS**

### **Group 1 — General Systemic effects of endrin**

**A. Initial experiments.** Severe tonic-clonic convulsions usually commenced within five to ten minutes after the beginning of endrin infusion. Convulsions, as well as hyperexcitability to stimulation and copious, mucoid salivation, lasted until death. Convulsions could be initiated by a sharp sound. Because of technical difficulties ensuing from the violent convulsions and hyperexcitability following endrin administration, it was necessary to give repeat injections of sodium pentobarbital (25-50 mg per injection) every few minutes during the first 60 minute post-endrin period. Although each injection of barbiturate usually decreased arterial blood pressure the animals' tolerance to this drug was greatly enhanced after endrin.

Figure 1 and Table 1-A shows the measured parameters. Bradycardia, followed by a return towards or above control value, was seen in each experiment. Mean systemic arterial blood pressure always decreased initially, but increased toward the control level in two experiments. Increased rectal temperature, hemocoagulation, decreased venous blood pH and increased leukocyte concentration also occurred. Leukocytosis always resulted from increased neutrophil concentration. Immature neutrophils were evident with the neutrophilia. Hemolysis was present in every post-endrin hematocrit sample. Alcohol blank infusions had no cardiovascular effects and did not cause hemolysis.

Table 1-A depicts mean values for differential leukocyte counts. The trend was toward neutrophilia. The appearance of a number of immature neutrophils also was noted.

**B. Experiments with succinylcholine.** Succinylcholine completely prevented convulsions in each experiment. Data shown in Figure 1 and Table 1-B indicate that the results from these experiments were similar to those of the preceding studies with the exception of arterial blood pressure changes. In this series, arterial blood pressure always increased initially, but subse-

quently fell to hypotensive levels in all but one study. Blood pH also decreased more and hemoconcentration was more pronounced in these animals than in the previous group. Cardiovascular alterations exhibited here were presumably not related to succinylcholine muscle relaxant as demonstrated by control experiments and reports in the literature (23-25). In some of these animals bradycardia was replaced by tachycardia in a manner resembling vagal escape. Following this phenomenon the heart rate would often oscillate between bradycardia and tachycardia.

*C. Control experiments.* Figure 3 shows data from six control animals receiving no endrin. No changes comparable to those seen in the dogs which received endrin were demonstrated. Mean values for leukocyte differentials are presented in Table 1-C.

#### *Group 2 — Effect of endrin on heart rate*

Figure 4 shows mean values of control and post-endrin heart rates. Atropine, injected when the post-endrin bradycardia was pronounced, was followed within 30 seconds by an increased heart rate to near control levels. Figure 5 shows portions of photographed records from two studies demonstrating immediate reversal of bradycardia following intravenous injection of Atropine.

#### *Group 3 — Effect of endrin on cerebrospinal fluid pressure*

Figures 6 and 7 (graphed data and photographed record respectively) show the development of increased cerebrospinal fluid (CSF) pressure as well as arterial hypertension and bradycardia. Cerebrospinal fluid pressure elevation precedes arterial hypertension, but may follow the appearance of bradycardia. Figure 8 shows photographed portions of two records in which the elevated CSF pressure was lowered by fluid withdrawal to approximately zero mm Hg for several minutes and subsequently returned to the elevated level. No significant effect on arterial blood pressure or heart rate was demonstrated. In the lower record, intracranial fluid pressure is also shown. Lowering CSF pressure by fluid withdrawal at the cis-

terna magna level resulted in an equivalent decrease in intracranial fluid pressure measured in the subarachnoid space.

In three experiments in which sagittal venous sinus (SVS) pressure was monitored, it was seen to increase rapidly with CSF pressure elevation while peripheral internal jugular vein pressure did not change. It was not possible to determine which pressure rise occurred first. Transmitted pulse pressure in the SVS and CSF increased significantly following endrin, the greater increase being in the SVS tracing. Lowering CSF pressure had no appreciable effect on SVS pressure. Sagittal venous sinus pressure could be lowered only a few mm Hg by withdrawing blood from the SVS; however, pressure changes in the sinus were followed closely by CSF pressure changes. Hypertension or bradycardia was never significantly affected by rapidly decreasing CSF pressure via fluid withdrawal, nor were these phenomena prevented by preventing CSF pressure from increasing. Maintaining CSF pressure at control level did not prevent the rise in SVS pressure.

### DISCUSSION

Cardiovascular alterations produced by acute endrin poisoning in the dog include hypertension and severe bradycardia. The fact that bradycardia and hypotension may develop simultaneously (Group 1-A), or that bradycardia may precede hypertension (Group 1-B) indicates the independence of these two phenomena. The initial hypotension exhibited in some dogs was apparently caused by repeated injections of sodium pentobarbital used to control the convulsions and hyperexcitability.

Bradycardia, reversible with Atropine, was a consistent finding. It appeared to result from increased vagal activity and/or a potentiation of acetylcholine. Increased acetylcholine activity could be related to the fall in pH since cholinesterase activity decreases with decreasing pH. This phenomenon has also been observed in animals acutely stressed with dieldrin (16) and aldrin (17). Bradycardia, copious mucoid salivation, hypertension, convulsions and other manifestations following endrin suggest that both sympathetic and parasympathetic nervous systems are hyperactive after endrin. Although elevated cerebrospinal fluid (CSF)

pressure can produce bradycardia and hypertension (26, 27), this relationship was apparently not observed in the present study. Acutely lowering the elevated CSF pressure to control level by fluid withdrawal or preventing CSF pressure from increasing did not alter the degree of bradycardia or hypertension. Cerebral venous blood pressure alterations may have been associated with the cardiovascular responses after endrin. Maintaining CSF pressure at near control level did not prevent elevation of sagittal venous sinus (SVS) pressure. Increased cerebral venous blood pressure may decrease the arteriovenous pressure difference across the cerebral vasculature and produce cerebral hypoxia if of sufficient magnitude. Hypoxia of the medulla could contribute to both bradycardia and hypertension. Increased SVS pressure could result from cerebral arteriolar dilatation or cerebral venous constriction, which would increase brain volume and CSF pressure. Extracerebral arterial blood pressure increase followed the rise in SVS pressure and central venous blood pressure did not increase after endrin. Therefore, these factors do not appear to contribute to the initial SVS pressure elevation.

Endrin appears to have a direct action on the medulla, as bradycardia often develops before CSF or SVS pressure increase. Convulsions and hyperexcitability were probably caused by endrin acting directly on the motor cortex and/or spinal cord. Increased body temperature, which was moderate except in two cases, could have resulted from a central action of endrin and altered metabolic rate. Convulsions also appear to contribute since the rise in temperature seems greater in convulsion animals which were not treated with succinylcholine.

The majority of animals exhibited large increases in the concentration of leukocytes. Conditions of manual work or exercise are accompanied by leukocytosis (28, 29) which is consistent with the findings in the convulsive

dogs. However, convulsions are apparently not prominently involved because the animals which did not exhibit convulsions (succinylcholine treated) showed a greater leukocytosis than the convulsing dogs. Both mobilization of stored leukocytes and increased bone marrow production, indicated by the appearance of immature neutrophils in the plasma, appear to have contributed to the increased plasma leukocyte concentration.

The hemoconcentration observed in most animals could result from (a) release of erythrocytes from the spleen (30, 31), (b) increased capillary permeability, or (d) stimulatory action of endrin on erythropoietic bone marrow tissue.

The trend toward acidosis during endrin intoxication did not appear to be of respiratory origin since increasing ventilatory rate did not prevent the decreased pH. Decreased perfusion and/or increased metabolic rate could explain the acidosis.

A schema of the possible mechanisms of action of endrin insecticide is presented in Figure 9.

#### SUMMARY

Cardiovascular effects of endrin insecticide are obscure. Experiments to investigate these phenomena were carried out on dogs and suggested mechanisms of action have been proposed. Results show that acute administration of endrin produces bradycardia, hypertension, copious salivation, hyperexcitability, tonic-clonic convulsions, increased body temperature, leukocytosis, hemoconcentration and decreased blood pH. Cerebral venous pressure and cerebrospinal fluid pressure elevations are also prominent features of endrin poisoning. Although most of these effects appear to be caused by endrin acting directly on the central nervous system some may result secondarily from altered cerebral hemodynamics. A schema of the possible mechanism of action of endrin has been presented.

## REFERENCES

1. E. Danopoulos, K. Melissinos, and G. Katsas. *Arch. Ind. Hyg. Occupational Med.* 8, 582 (1953).
2. *A Bell. Med. J. Australia*, 2, 698 (1960).
3. M. R. Zavon, and R. E. Hamman. *Amer. J. Public Health*, 51, 1026 (1961).
4. J. E. Chapman, and C. E. Lewis. *J. Kansas Med. Soc.* 63, 228 (1962).
5. A. A. Buck, and L. Pfannemuller. *Arch Toxicol.* 16, 328 (1957).
6. J. M. Arena. *N. Carolina Med. J.* 21, 470 (1960).
7. O. Stur, and E. Zweymueller. *Deut. med. Wochschr.* 86, 1474 (1961).
8. L. Friberg, and J. Martensson. *Arch. Ind. Hyg. Occupational Med.* 8, 166 (1953).
9. W. J. Hayes, Jr. *Ann. Rev. Entomol.* 5, 379 (1960).
10. H. Reyes. *Bol Chileno Parasitology*, 15, 57 (1960).
11. J. Blazques, and C. Bianchini. *Bol. ofic. sanit. panam.* 43, 504 (1957).
12. B. E. Conley. (Secretary, Committee on Toxicol.) *J. Am. Med. Assoc.* 173, 2077 (1960).
13. J. F. Treon, F. P. Cleveland, and J. J. Cappel. *Agri. Food Chem.* 3, 843 (1955).
14. F. DeMatteis, B. E. Prior, and C. Rimington. *Nature (London)*, 191, 363 (1961).
15. R. K. Oekner, and R. Schmid. *Nature (London)*, 189, 499 (1961).
16. C. W. Gowdey, A. R. Graham, J. J. Seguin, and C. W. Stavraky. *Can. J. Biochem. Physiol.* 32, 498 (1954).
17. C. W. Gowdey, A. R. Graham, J. J. Seguin, G. W. Stavraky, and R. A. Waud. *Can. J. Med. Sci.* 30, 520 (1952).
18. E. P. Laug, F. M. Kunze, and C. S. Prickett. *Arch Ind. Hyg. Occupational Med.* 3, 245 (1951).
19. S. T. Read, and W. P. McKinley. *Arch Environ. Health*, 3, 209 (1961).
20. W. J. Hayes, Jr., W. F. Durham, and C. Cueto, Jr. *J. Am. Med. Assoc.* 162, 890 (1956).
21. E. P. Laug. *J. Pharmacol. Exp. Therap.* 93, 277 (1948).
22. J. R. Busvine. *Practitioner*, 188, 267 (1962).
23. J. C. Bourne, H. O. J. Collier, and G. F. Somers. *Lancet*, 1, 1225 (1952).
24. P. C. Lund. *Am. J. Surgery*, 86, 312 (1953).
25. O. Von Dardel, and S. Thesleff. *Acta Chir. Scand.* 103, 321 (1952).
26. G. S. Campbell, F. J. Haddy, W. L. Adams, and M. B. Visscher. *Am. J. Physiol.* 158, 96 (1949).
27. H. Cushing. *Bull. Johns Hopkins Hosp.* 12, 290 (1901).
28. W. E. Garrey, and W. R. Bryan. *Physiol. Rev.* 15, 597 (1935).
29. M. J. Karvonen, and M. Kunnas. *Acta Physiol. Scand.* 29, 220 (1953).
30. J. Barcroft. *Am. J. Med. Sci.* 179, 1 (1930).
31. W. G. Guntheroth, and G. L. Mullins. *Am. J. Physiol.* 204, 35 (1963).



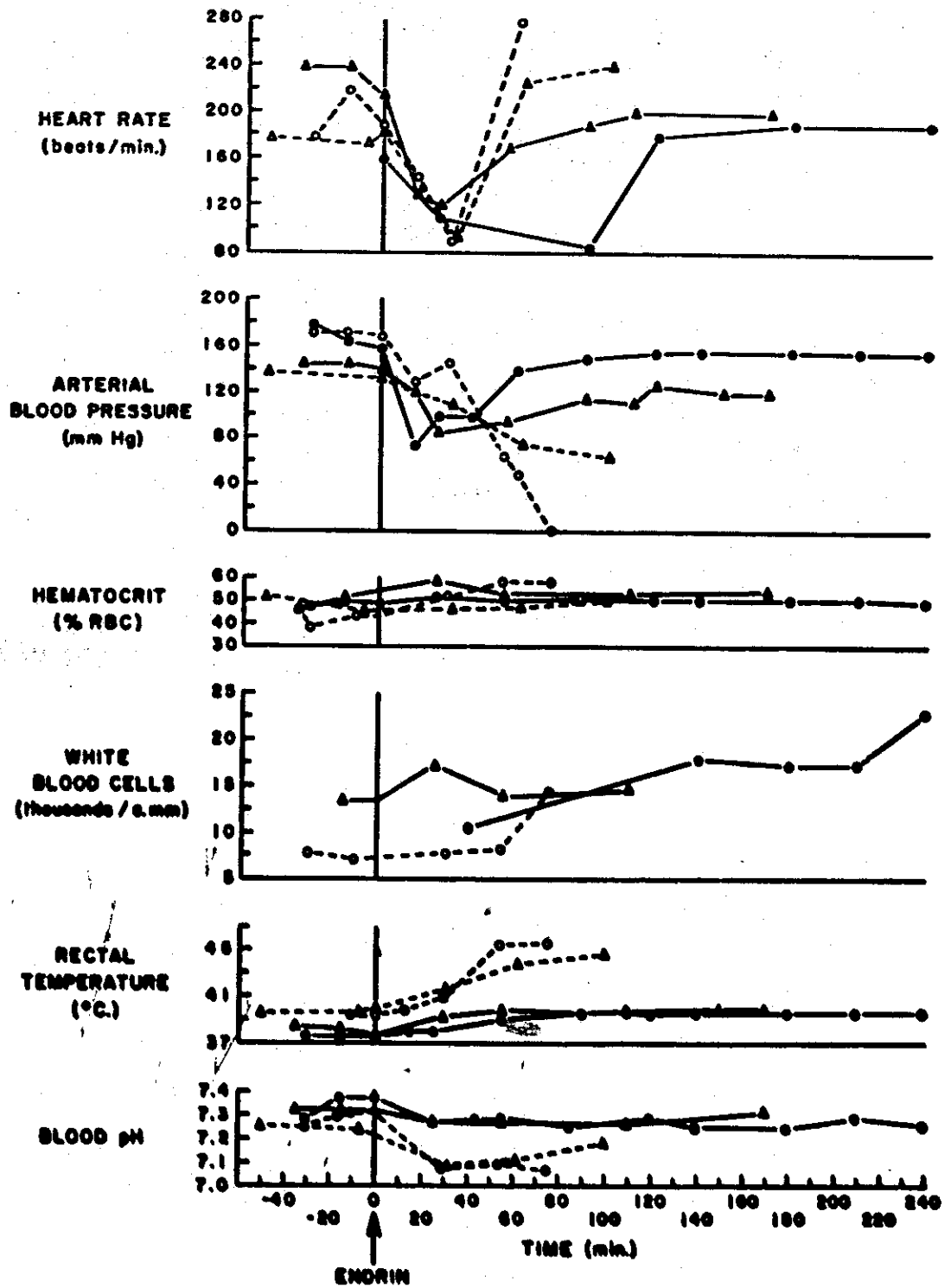

FIGURE 1. - Cardiovascular and hematological alterations produced by endrin insecticide are shown on the ordinate. Time, before and after endrin infusion, is indicated on the abscissa. Endrin infusion was started at the arrow.

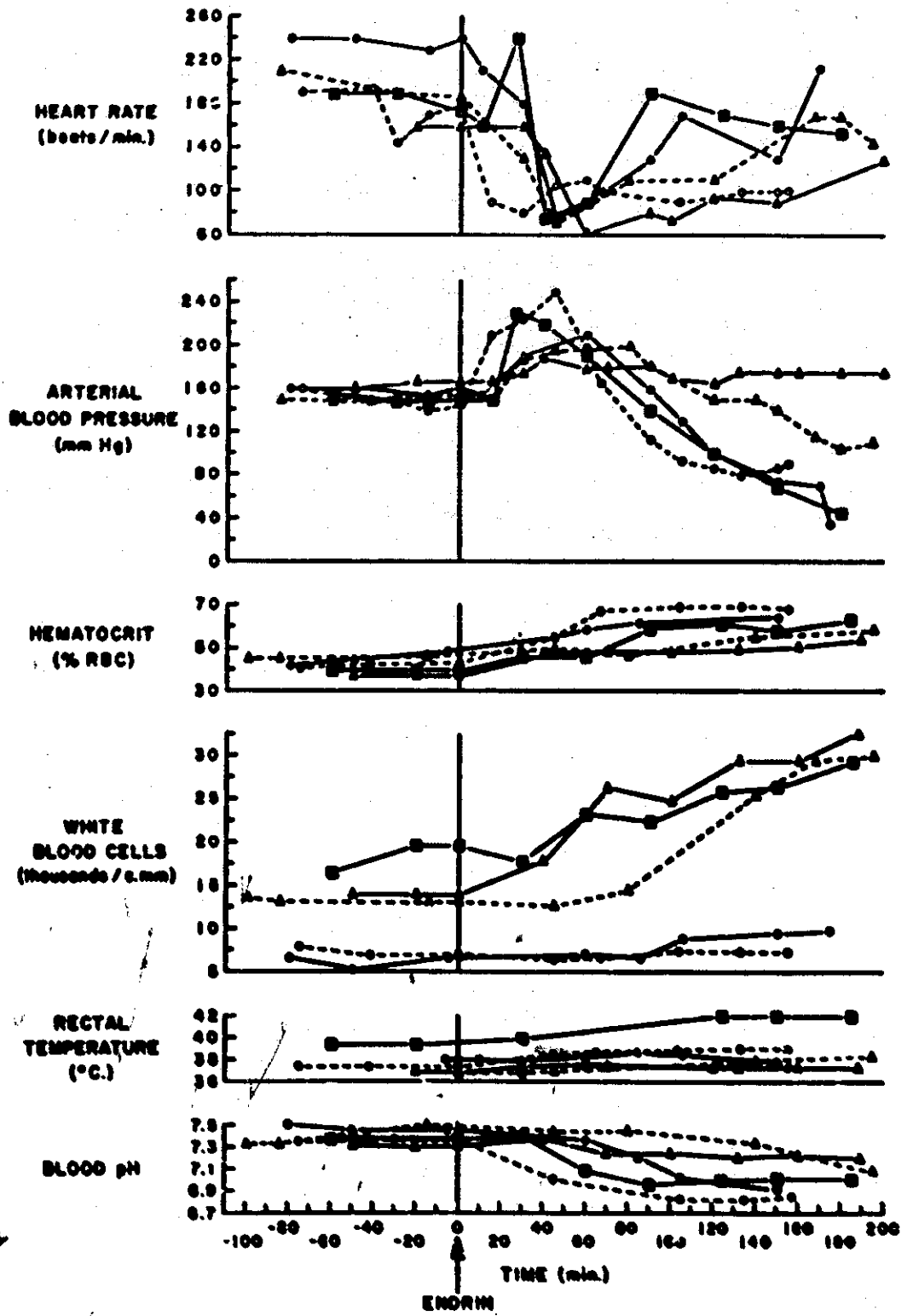

FIGURE 2. - Cardiovascular and hematological alterations produced by endrin in Aroclor treated dogs are plotted on the ordinates. Time, before and following endrin infusion, is indicated on the abscissa.

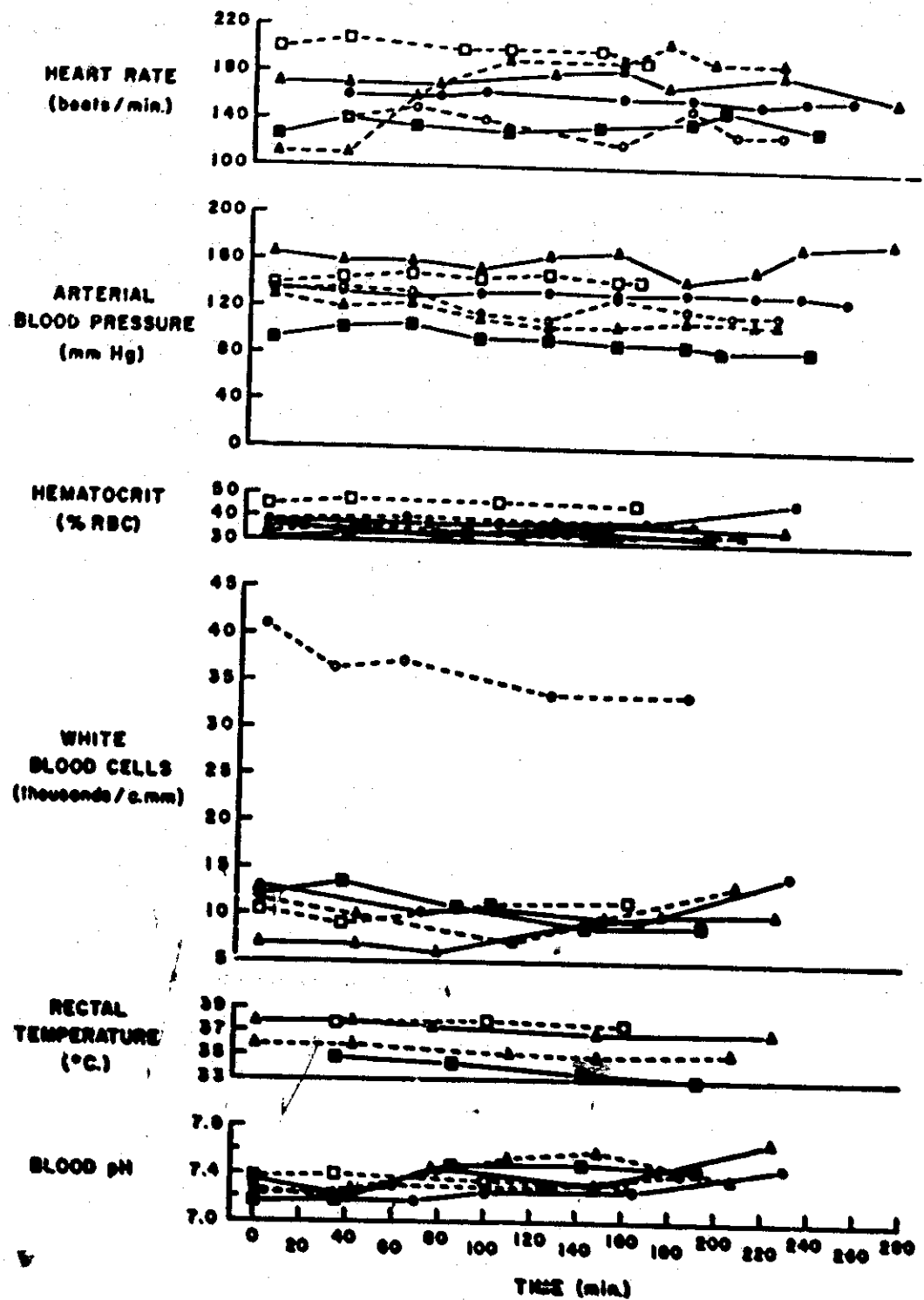

FIGURE 3. - Cardiovascular and hematological measurements obtained from animals receiving no ecdria are plotted on the ordinate against time on the abscissa.

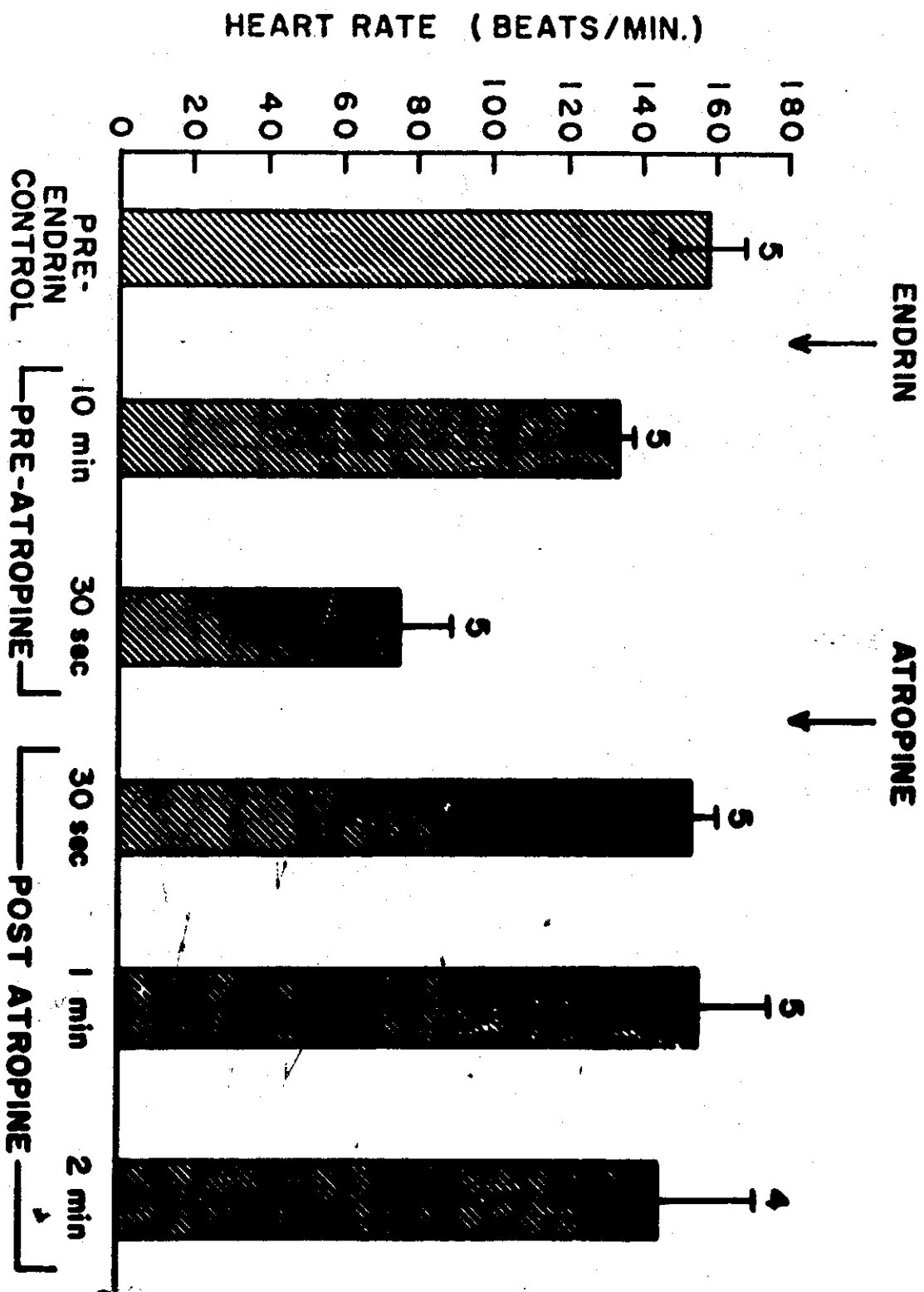

FIGURE 4. — Mean values ( $\pm$  S. E.) of heart rates before and after endrin and atropine respectively are shown. Bradycardia produced by endrin is immediately reversed by atropine.

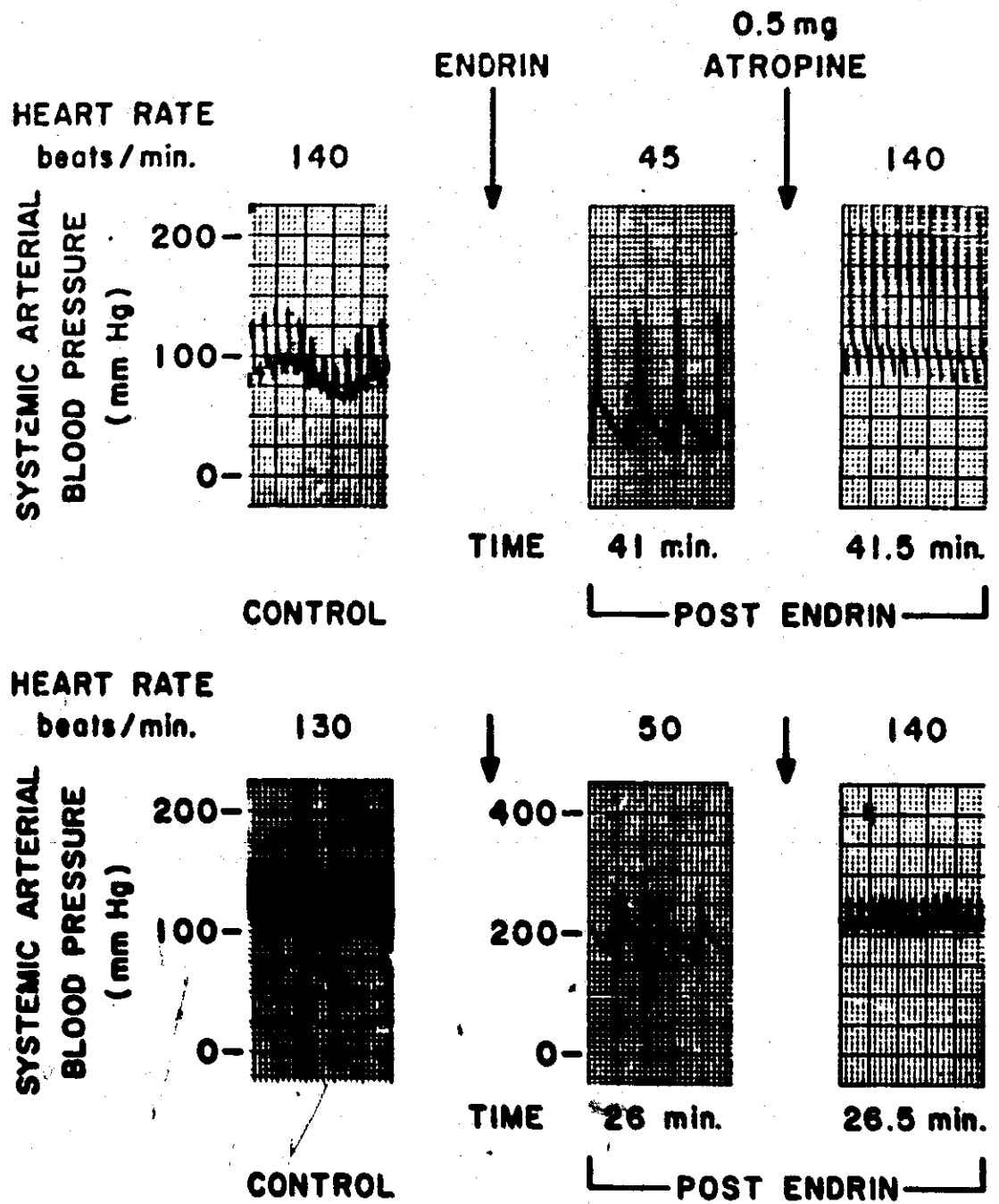

Figure 3. - Records from two typical experiments are presented demonstrating reversibility of the post-endrin bradycardia by atropine.

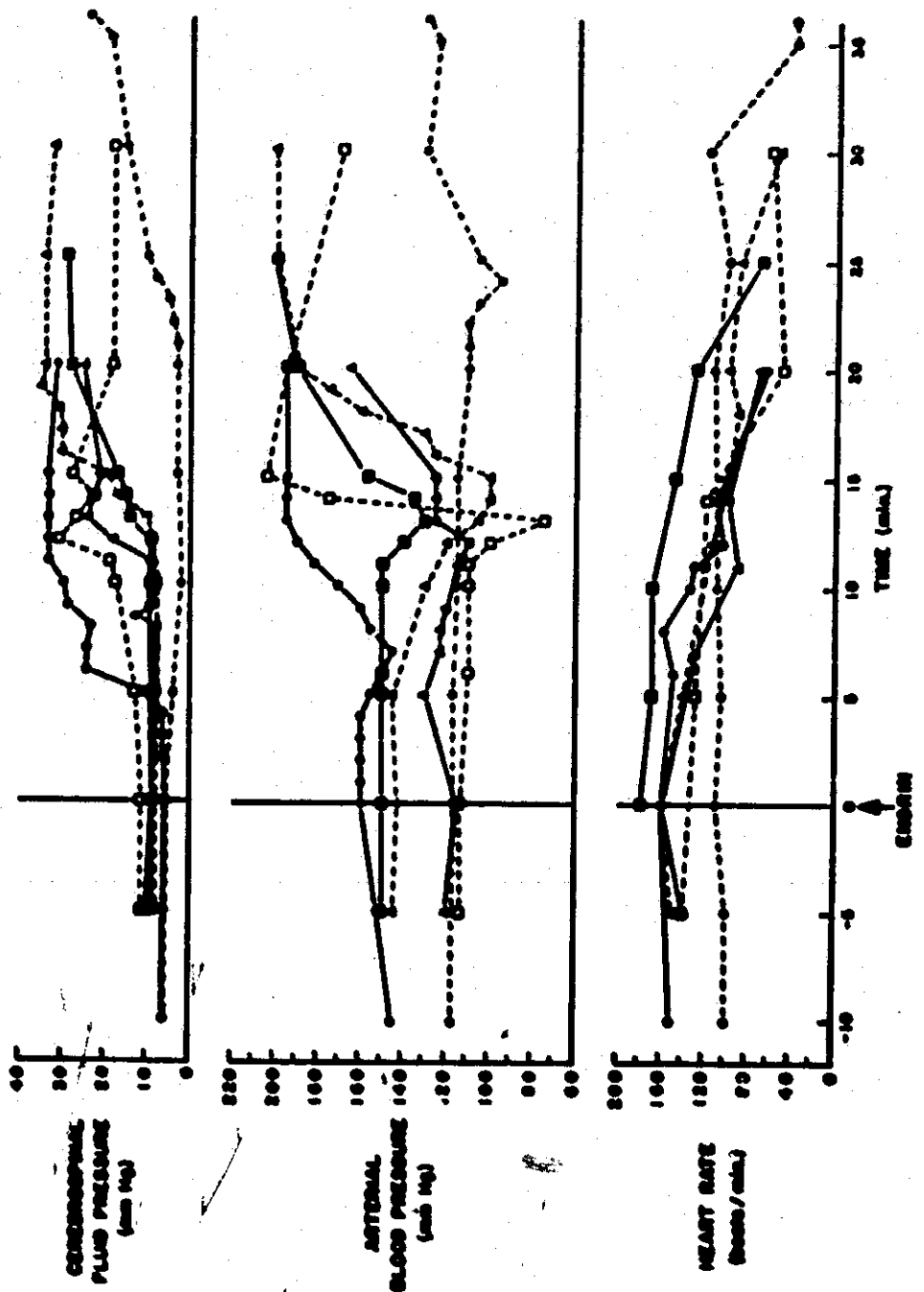

FIGURE 8. - Development of bradycardia, elevated cerebrospinal fluid pressure, and hypertension following epinephrine administration is shown in six animals.

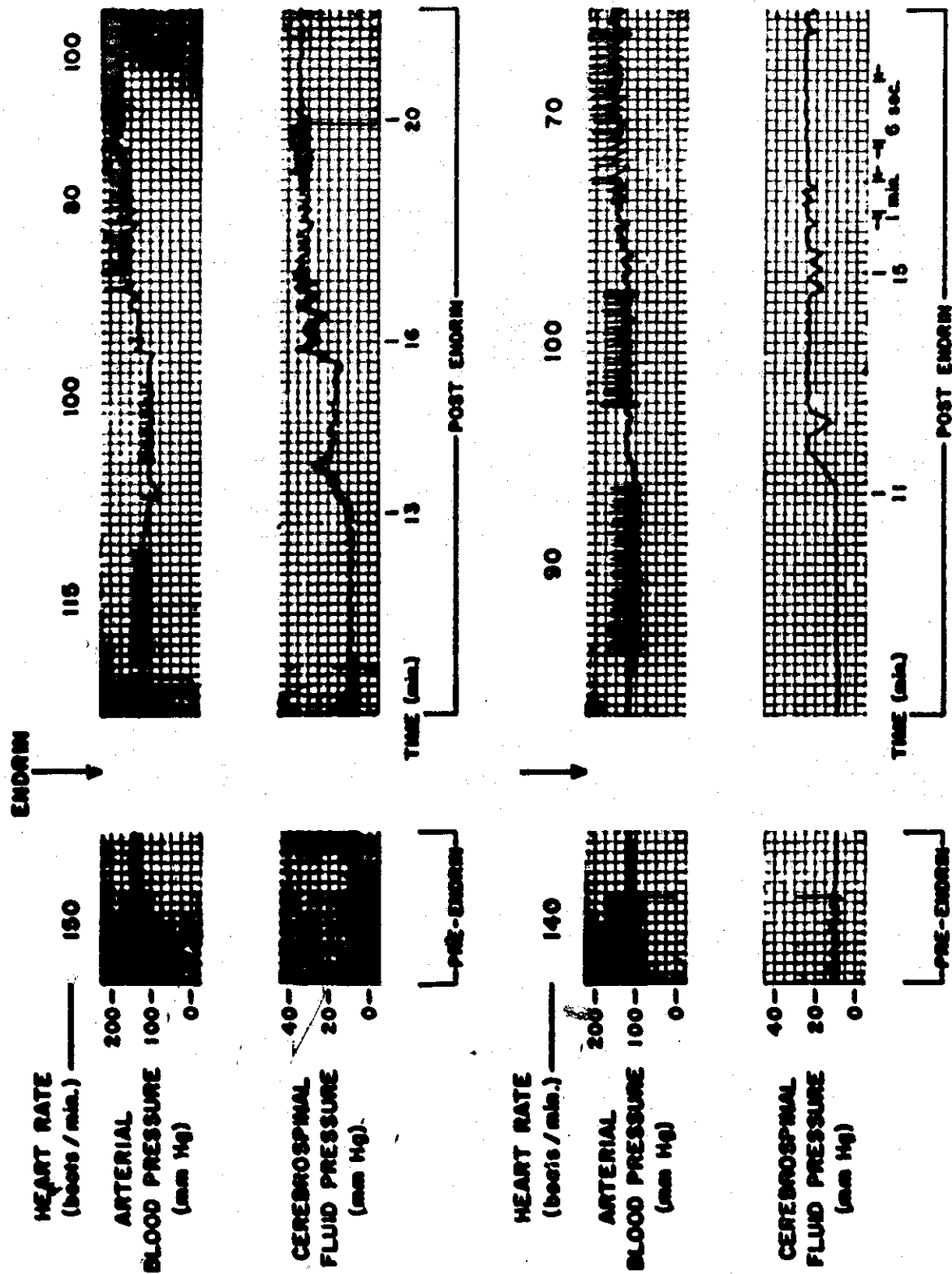

Figure 7. -- Records from two experiments showing the development of bradycardia, elevated cerebrospinal fluid pressure, and hypertension are shown.

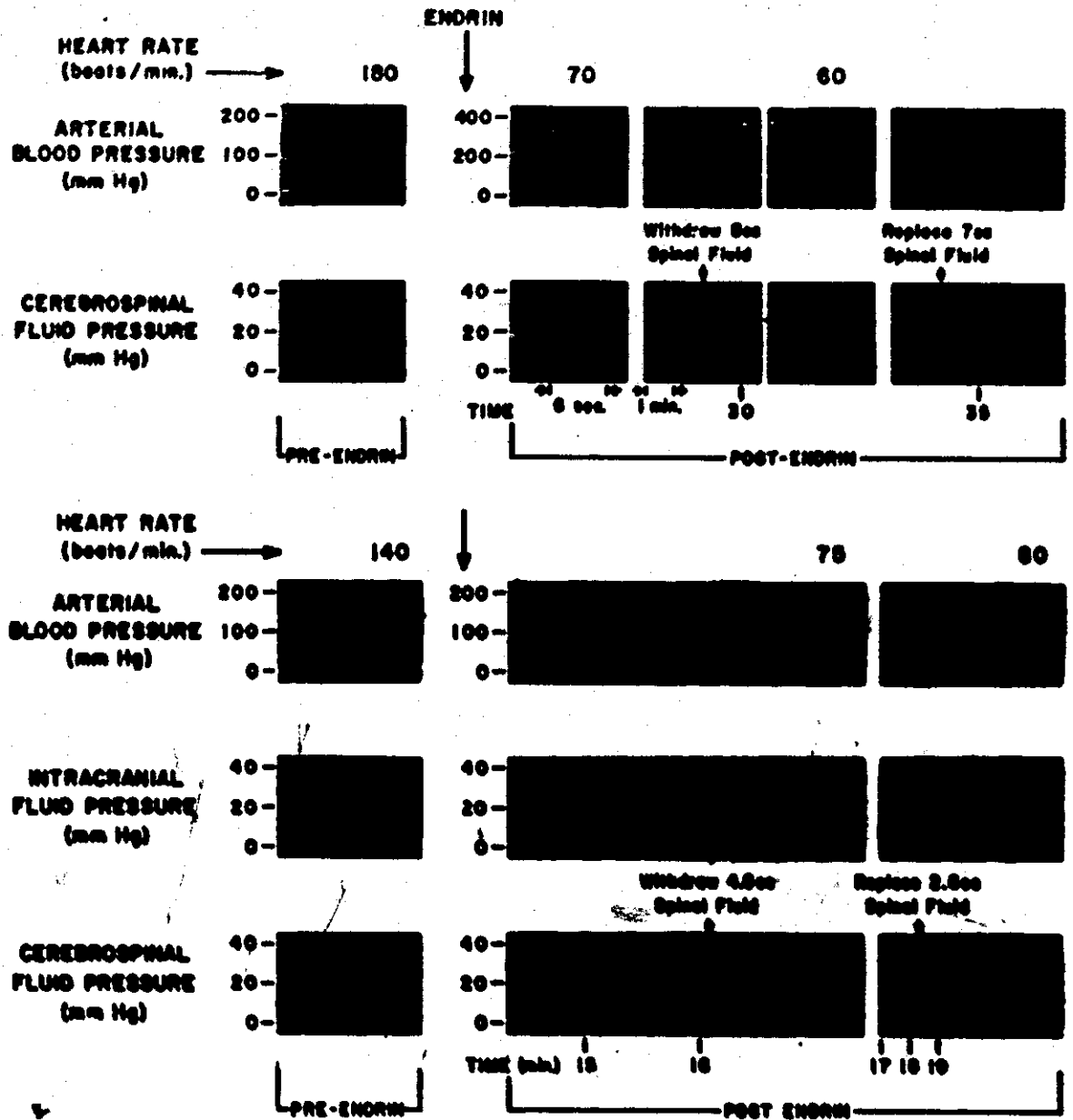

Figure 2 - Records from two typical experiments demonstrating an effect on bradycardia or hypertension by lowering the elevated cerebrospinal fluid pressure. Lower record also shows that intracranial fluid pressure (measured in the subarachnoid space) changes follow spinal fluid pressure changes closely.



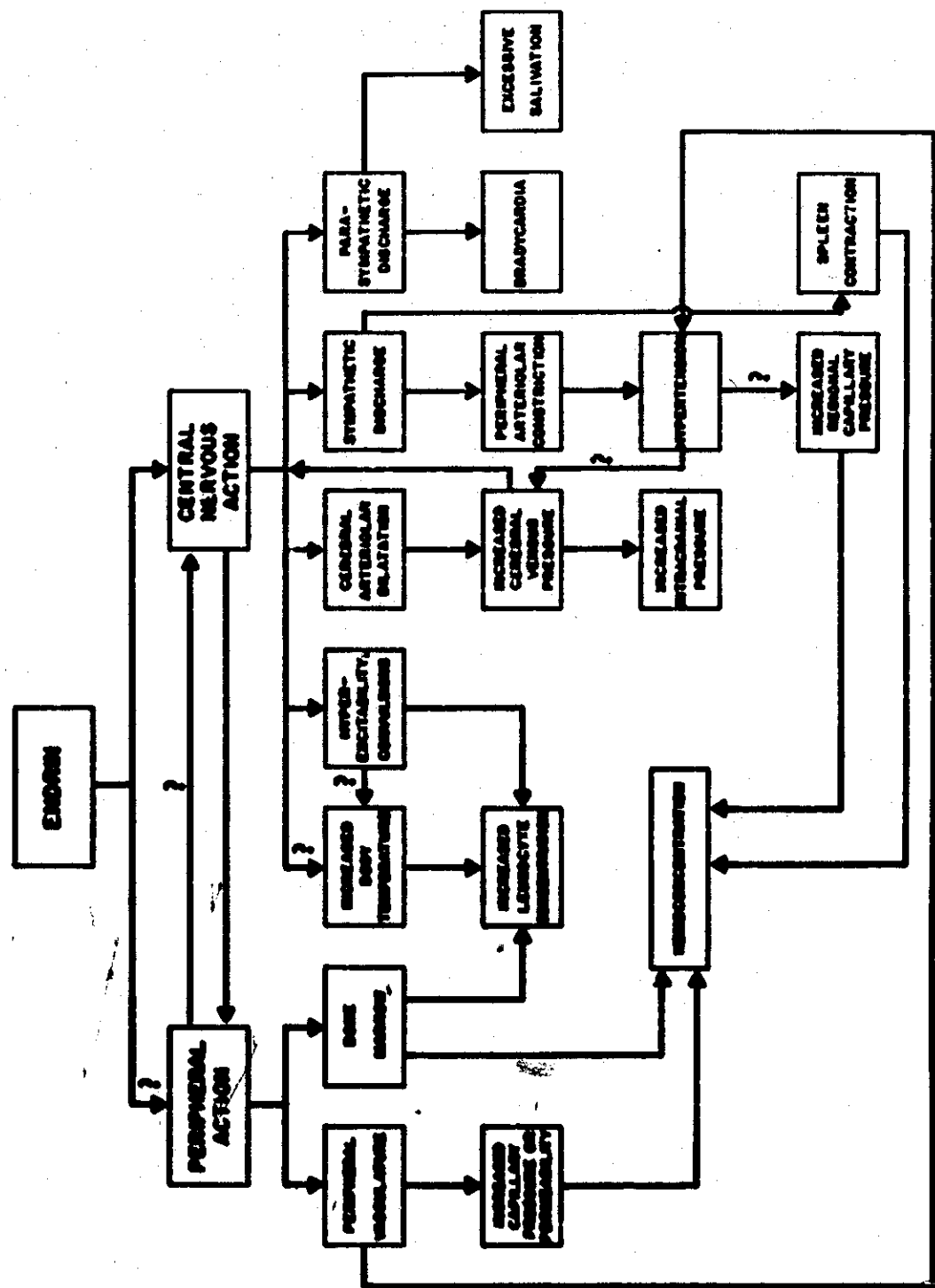

Figure 8 - A possible scheme of action of endrin based on results from present work

TABLE 1  
TABLE 1-A

TYPE LEUKOCYTE	CONTROL ( $\pm$ S. E.)	POST-ENDRIN		
		30-60 MIN	60-120 MIN	120-180 MIN
Neutrophils	53 $\pm$ 2.8	60 $\pm$ 9.6	71 $\pm$ 9.0	66 $\pm$ 2.6
Eosinophils	12 $\pm$ 5.0	9 $\pm$ 3.8	6 $\pm$ 2.6	9 $\pm$ 0.6
Basophils	1 $\pm$ 0.6	1 $\pm$ 0.7	1 $\pm$ 0.6	0
Lymphocytes	21 $\pm$ 5.2	21 $\pm$ 5.2	16 $\pm$ 5.0	10 $\pm$ 6.5
Monocytes	13 $\pm$ 5.6	8 $\pm$ 1.6	7 $\pm$ 2.6	8 $\pm$ 5.0
No. of Experiments	3	3	3	2

TABLE 1-B

TYPE LEUKOCYTE	CONTROL ( $\pm$ S. E.)	POST-ENDRIN		
		30-60 MIN	60-120 MIN	120-180 MIN
Neutrophils	70 $\pm$ 1.8	74 $\pm$ 4.7	81 $\pm$ 5.6	84 $\pm$ 2.8
Eosinophils	5 $\pm$ 2.2	1 $\pm$ 0.8	2 $\pm$ 0.9	1 $\pm$ 0.7
Basophils	1 $\pm$ 0.6	1 $\pm$ 0.6	0 $\pm$ 0.1	0 $\pm$ 0
Lymphocytes	17 $\pm$ 2.4	19 $\pm$ 3.9	13 $\pm$ 2.9	8 $\pm$ 2.3
Monocytes	8 $\pm$ 1.3	7 $\pm$ 0.9	5 $\pm$ 0.7	8 $\pm$ 1.5
No. of Experiments	5	4	4	5

TABLE 1-C

TYPE LEUKOCYTE	CONTROL ( $\pm$ S. E.)	POST-ANECTINE		
		30-60 MIN	60-120 MIN	120-180 MIN
Neutrophils	80 $\pm$ 7.1	80 $\pm$ 1.7	85 $\pm$ 2.2	85 $\pm$ 3.7
Eosinophils	3 $\pm$ 1.1	2 $\pm$ 1.0	2 $\pm$ 1.2	2 $\pm$ 1.2
Basophils	0 $\pm$ 0.4	0 $\pm$ 0.2	0 $\pm$ 0	0 $\pm$ 0.2
Lymphocytes	9 $\pm$ 4.8	11 $\pm$ 4.5	5 $\pm$ 1.8	6 $\pm$ 2.6
Monocytes	8 $\pm$ 1.1	6 $\pm$ 1.2	9 $\pm$ 0.9	7 $\pm$ 1.5
No. of Experiments	5	6	5	4

TABLE 1: A-Mean leukocyte differential counts ( $\pm$  S.E.) from dogs receiving endrin; B-Mean leukocyte differentials ( $\pm$  S.E.) for dogs receiving endrin and anectine; C-Mean leukocyte differentials ( $\pm$  S.E.) from control animals receiving no endrin.

Civil Aeronautical Research Institute, Federal Aviation Agency, Oklahoma City, Oklahoma. CARI Report 63-16. MECHANISMS OF ACTION OF THE INSECTICIDE ENDRIIN by Thomas E. Emerson, Jr., Charles M. Brake and Lester B. Hinchelaw.

1. Insecticides
2. Toxicology
3. Hemodynamics
4. Hematology

Cardiovascular effects of endrin insecticide are obscure. Experiments to investigate these phenomena were carried out on dogs and suggested mechanisms of action have been proposed. Results show that acute administration of endrin produces bradycardia, hypertension, copious salivation, hyperexcitability, tonic-clonic convulsions, increased body temperature, leukocytosis, hemocoagulation and decreased blood pH. Cerebral venous pressure and cerebrospinal fluid pressure elevations are also prominent features of endrin poisoning. Although most of these effects appear to be caused by endrin acting directly on the central nervous system some may result secondarily from altered cerebral hemodynamics.

Civil Aeronautical Research Institute, Federal Aviation Agency, Oklahoma City, Oklahoma. CARI Report 63-16. MECHANISMS OF ACTION OF THE INSECTICIDE ENDRIIN by Thomas E. Emerson, Jr., Charles M. Brake and Lester B. Hinchelaw.

1. Insecticides
2. Toxicology
3. Hemodynamics
4. Hematology

Cardiovascular effects of endrin insecticide are obscure. Experiments to investigate these phenomena were carried out on dogs and suggested mechanisms of action have been proposed. Results show that acute administration of endrin produces bradycardia, hypertension, copious salivation, hyperexcitability, tonic-clonic convulsions, increased body temperature, leukocytosis, hemocoagulation and decreased blood pH. Cerebral venous pressure and cerebrospinal fluid pressure elevations are also prominent features of endrin poisoning. Although most of these effects appear to be caused by endrin acting directly on the central nervous system some may result secondarily from altered cerebral hemodynamics.

Civil Aeronautical Research Institute, Federal Aviation Agency, Oklahoma City, Oklahoma. CARI Report 63-16. MECHANISMS OF ACTION OF THE INSECTICIDE ENDRIIN by Thomas E. Emerson, Jr., Charles M. Brake and Lester B. Hinchelaw.

1. Insecticides
2. Toxicology
3. Hemodynamics
4. Hematology

Cardiovascular effects of endrin insecticide are obscure. Experiments to investigate these phenomena were carried out on dogs and suggested mechanisms of action have been proposed. Results show that acute administration of endrin produces bradycardia, hypertension, copious salivation, hyperexcitability, tonic-clonic convulsions, increased body temperature, leukocytosis, hemocoagulation and decreased blood pH. Cerebral venous pressure and cerebrospinal fluid pressure elevations are also prominent features of endrin poisoning. Although most of these effects appear to be caused by endrin acting directly on the central nervous system some may result secondarily from altered cerebral hemodynamics.

Civil Aeronautical Research Institute, Federal Aviation Agency, Oklahoma City, Oklahoma. CARI Report 63-16. MECHANISMS OF ACTION OF THE INSECTICIDE ENDRIIN by Thomas E. Emerson, Jr., Charles M. Brake and Lester B. Hinchelaw.

1. Insecticides
2. Toxicology
3. Hemodynamics
4. Hematology

Cardiovascular effects of endrin insecticide are obscure. Experiments to investigate these phenomena were carried out on dogs and suggested mechanisms of action have been proposed. Results show that acute administration of endrin produces bradycardia, hypertension, copious salivation, hyperexcitability, tonic-clonic convulsions, increased body temperature, leukocytosis, hemocoagulation and decreased blood pH. Cerebral venous pressure and cerebrospinal fluid pressure elevations are also prominent features of endrin poisoning. Although most of these effects appear to be caused by endrin acting directly on the central nervous system some may result secondarily from altered cerebral hemodynamics.